

ORAC  
CORPORATION

*30 years*  
OF  
EXCELLENCE



ORAC DECOR



ORAC MYLINE



ORAC AXENT

THE ART OF DECORATION



ORAC  
CORPORATION

catalogue 2007

ORAC Decor - ORAC Myline - ORAC Axxent



CORNICE MOULDINGS

ORAC DECOR	22
ORAC MYLINE	28
ORAC AXSENT	30



PANEL MOULDINGS

ORAC DECOR	34
ORAC MYLINE	38
ORAC AXSENT	40



SKIRTING

ORAC MYLINE	38
ORAC AXSENT	42



ORAC FLEX



PANELLING



BYBLOS

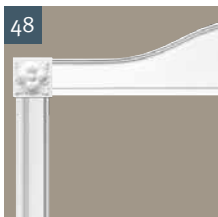

DOOR FRAMES

ORAC DECOR	50-51
ORAC AXSENT	50



PEDIMENTS



CEILING MEDALLIONS



CEILING ORNAMENTS

tiles	56
domes	57

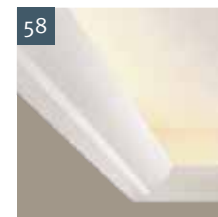

LIGHTING

fixtures	58
indirect - Decor	59
indirect - Myline	60
Xinnix®	62
LEDs	63



SHELVES AND CORBELS



NICHES



DECORATIVE ELEMENTS

mantel pieces	68
wall decoration	69



PILASTERS



COLUMNS

full	74
half	76
segmented XL	78



MARKETING TOOLS



TOOLS  
ADHESIVES



## ORAC DECOR®

*Exclusivity & Creativity*

The most complete range of high quality decorating items in Purotouch®.

### ORAC MYLINE

A pure, sober collection. Ideally suited for an environment in which austerity rhymes with subtlety. And beauty with functionality.



## ORAC AXXENT®

*Quality & Atmosphere*

A range with an exceptional value for money. Manufactured in Duropolymer®.



IL003 in SX118



L600, SX104

C O N T E M P O R A R Y



C358

SX104



C352, P5050, 2xL600, SX104



C360, P5050



C357



C333, B418

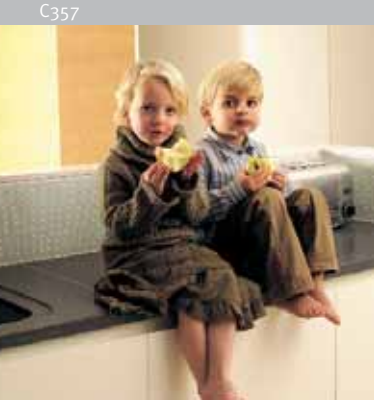

CX126, PX116, SX125

C O N T E M P O R A R Y



C352



DX119 PX120 SX118



H101, C400, P9040, E20, G40/41



PX113, PX103, SX118



P8040, P8020, SX118

COUNTRY STYLE



P9010 P9050 SX105 H100

COUNTRY STYLE



C333



L506, R40, C240



C422, Byblos, P9010



D130, D1014



C422, P9010



K1122



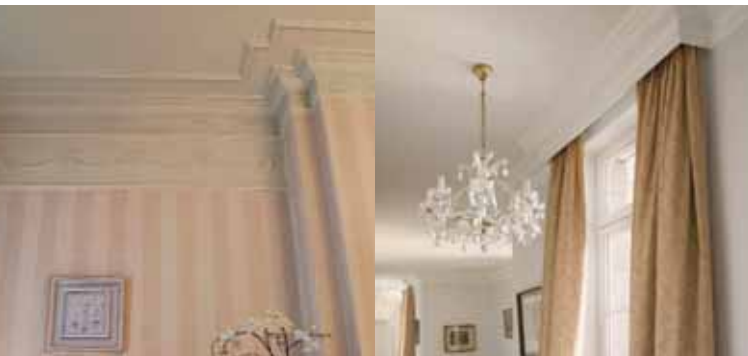

2xP4020, C901, P7020, G40/41

C334



C332

T R A D I T I O N A L C H I C



3xP4020, GB03



C422



Byblos, K223, K220



C334, Ro9



C334, K223, K220



P7040, D503, SX118

T R A D I T I O N A L C H I C



C900 + P4020

D401 + D402 + K200 + D320

P7030

SX118 + DX121



DX119 L600 SX105



P3020, R12, C214



CX123, PX120, PX103, SX105



C305+C215, P8020, D506 ...



CX108, SX118

ARTISTIC LIVING



C217 P9010 P9050 SX118

ARTISTIC LIVING

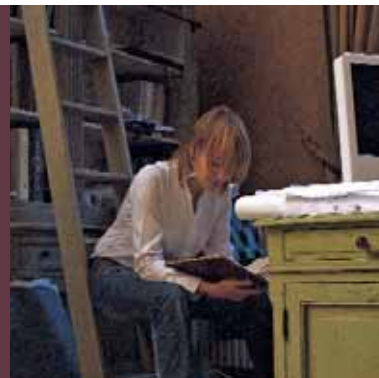

DX119, PX120, SX118



CX126



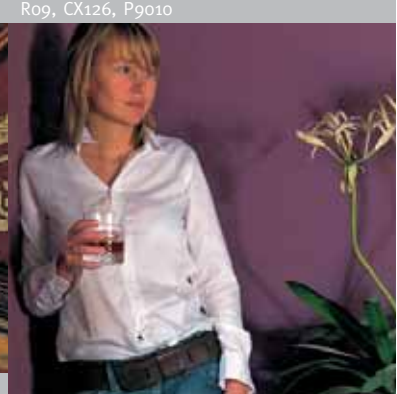



















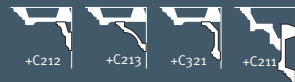

















R09, CX126, P9010



P7060 D210

smooth

L: 200cm

	C250/C250F			C213/C213F	
	C230/C230F			C240/C240F	
	C260/C260F			C305/C305F	
	C305/C305F			C321/C321F	
	C215/C215F			*C902/C902F	
	C322/C322F			C217/C217F	
	C331/C331F			C333/C333F	
	C602/C602F			C200/C200F	
	C400/C400F			C220/C220F	
	C200/C200F				
	C220/C220F				



P8020, C305

C213F

C215, C230

C333, C200

C333

C400

Exclusivity & Creativity

\* see indirect lighting, page 59

ref.+F = available in Flex, see page 44

smooth

ornamented

CORNICE MOULDINGS

L: 200cm

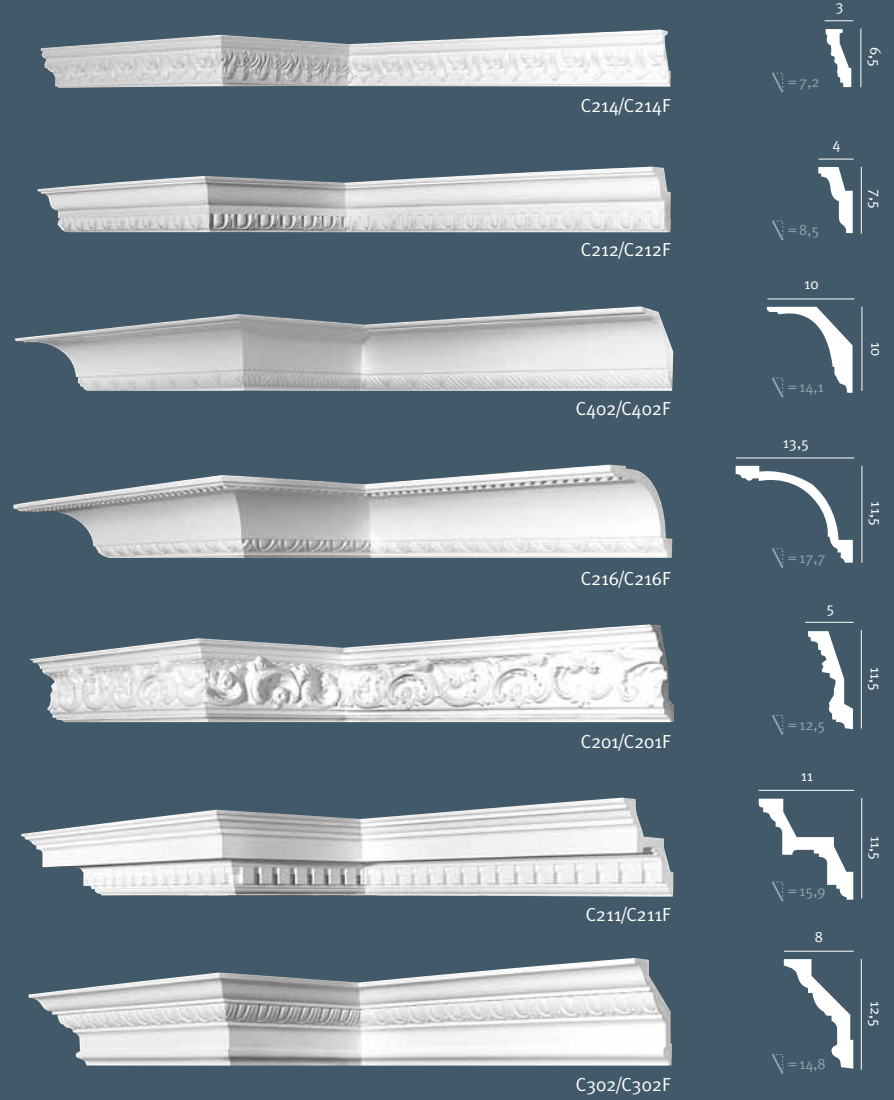
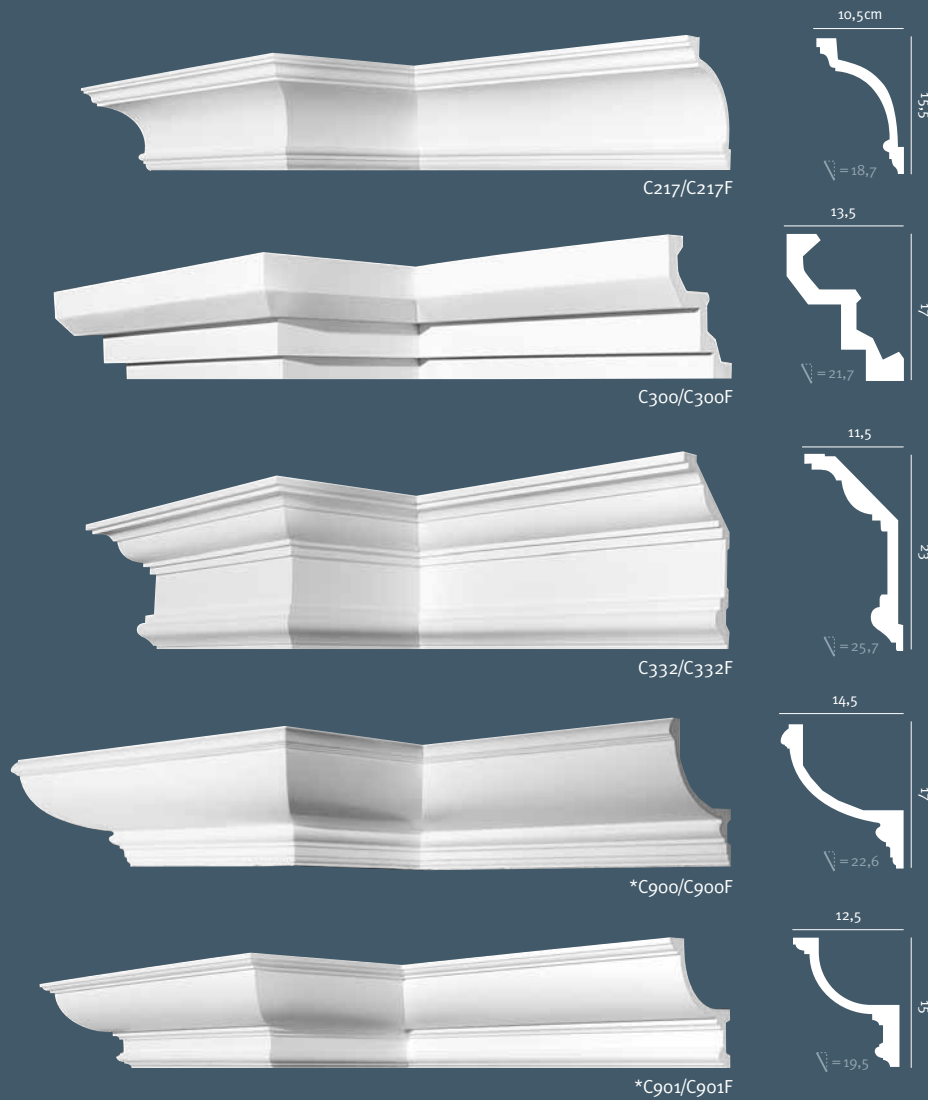

\* see indirect lighting, page 59

*Exclusivity & Creativity*

ref+F = available in Flex, see page 44

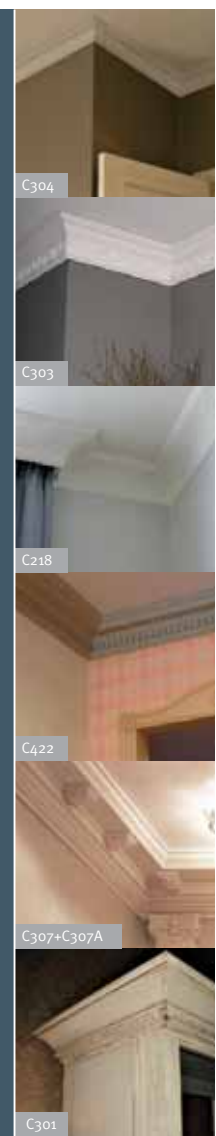
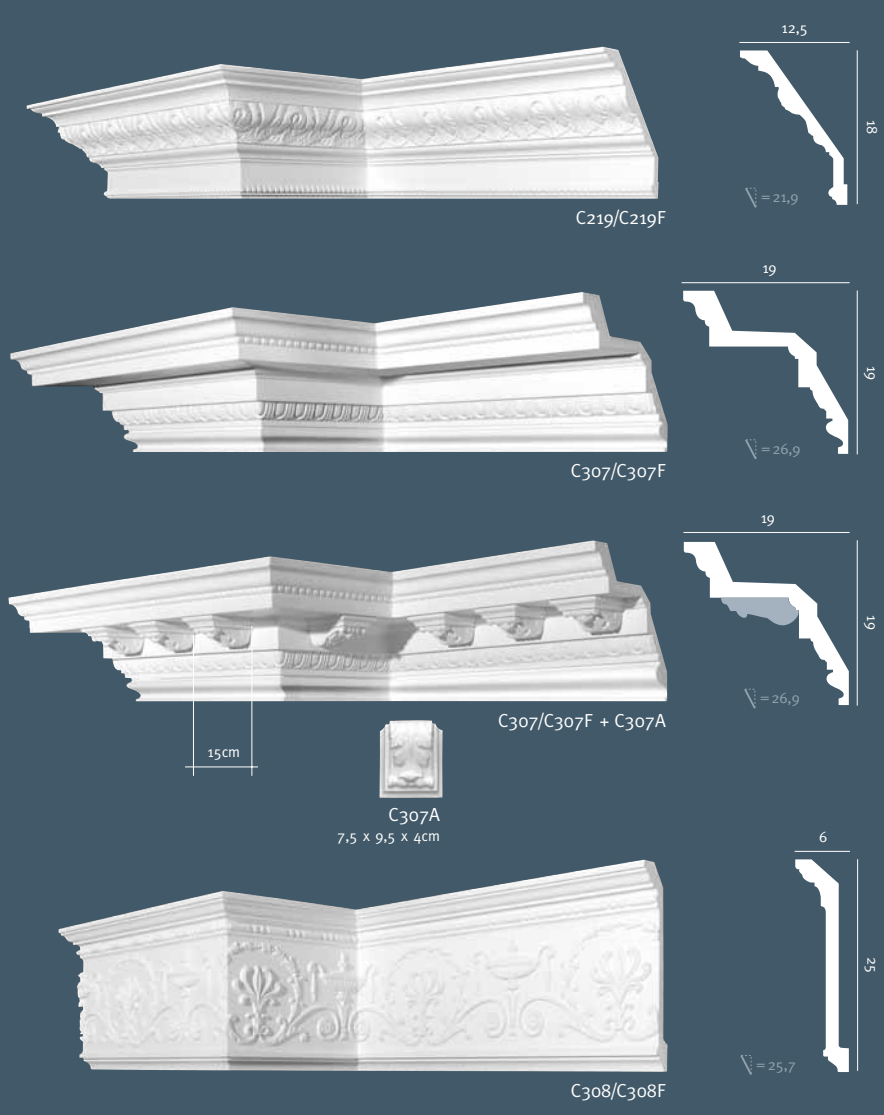
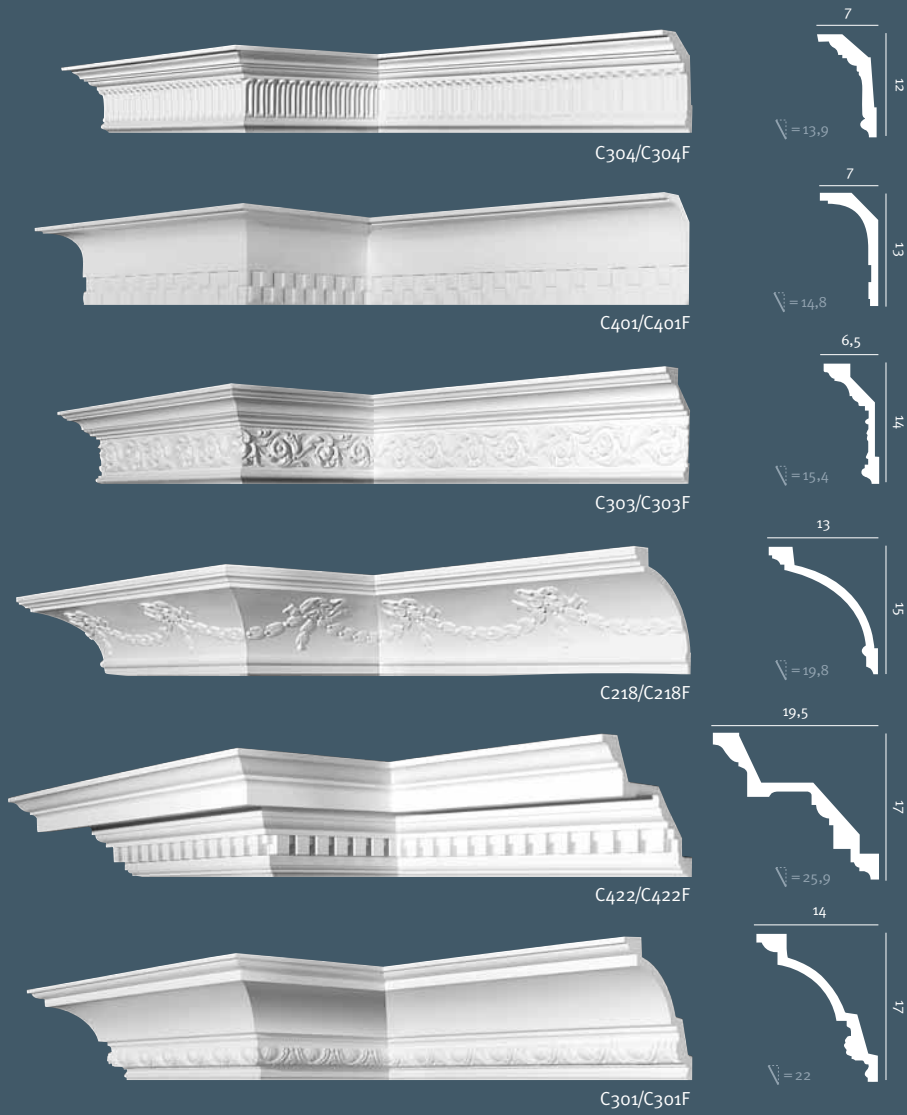

C360  
C360F



C356  
C356F



C351\*

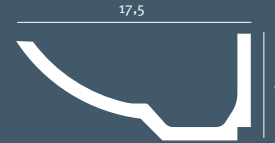

C352\*

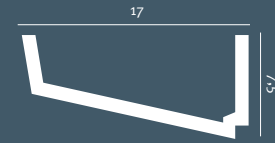

C355  
C355F

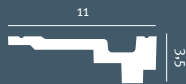

C353  
C353F



C357\*

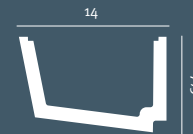

C358\*



C354  
C354F



C355

C353

C354

C351

C351, C356

C354

ref+F = available in Flex, see page 44.  
For ORAC Myline panel mouldings and skirting, see page 38.

\* see indirect lighting, page 60



smooth

DUROPOLYMER®

L: 200cm



ornamented

DUROPOLYMER®

L: 200cm

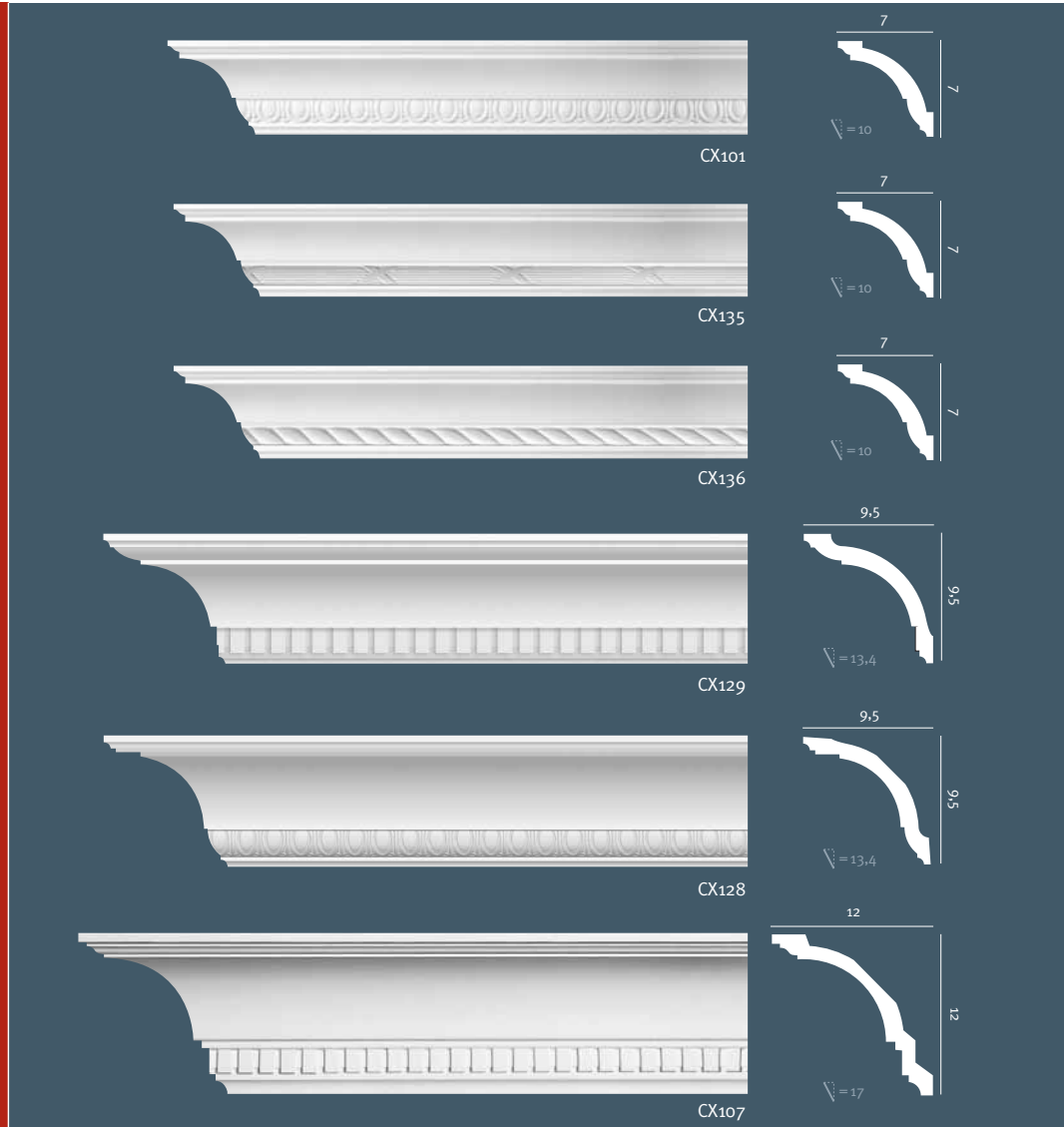

CORNICE MOULDINGS

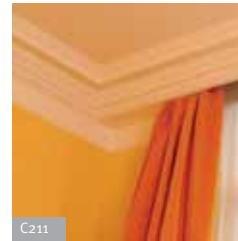
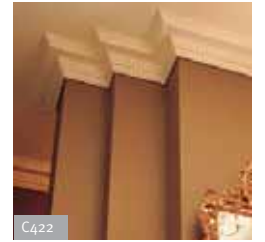

Quality & Atmosphere

smooth

PUROTOUCH®

with corner elements

PANEL MOULDINGS

L: 200cm



P9050/P9050F



P5021/P5021F



P9040/P9040F

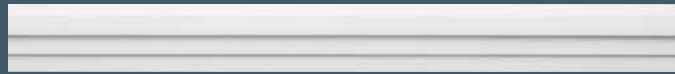

P7070/P7070F

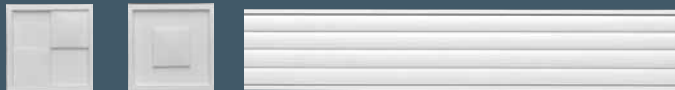

P5020A  
9 x 9 x 1,5cm

P5020B  
9 x 9 x 1,5cm

P5020/P5020F



P9010/P9010F



P9020/P9020F

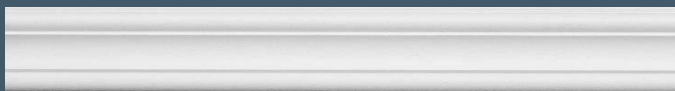

P8040/P8040F



P4020/P4020F



P4020A  
16,5 x 7 x 3cm

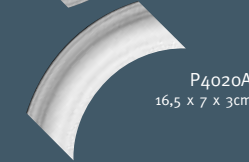

P4020A  
16,5 x 7 x 3cm



P8020/P8020F



P801C  
20 x 8,5 x 2,5cm

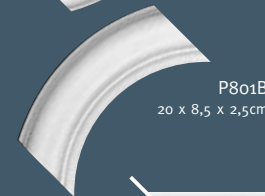

P801B  
20 x 8,5 x 2,5cm



P8030/P8030F



P8030C  
19 x 5,5 x 1,5cm



P8030B  
19 x 5,5 x 1,5cm



P8030D  
13 x 13 x 1,5cm



A x B x C (cm)



P8020, C305



P8020



3 x P4020



P8020, P8040



P8030(D), P4020, P20



P801C, P8020



P7050/P7050F



P3020/P3020F



P7060/P7060F



P7040/P7040F



P7030/P7030F



P7010/P7010F



P7020/P7020F

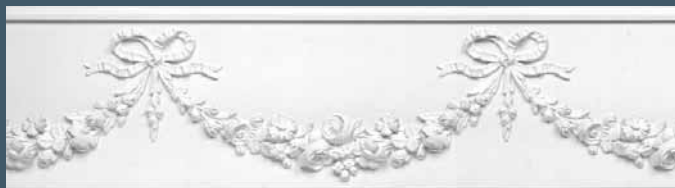

P7080/P7080F



P5010A  
9 x 9 x 1,5cm

P5010/P5010F



P20  
Ø6,5 x 1cm



P1020/P1020F

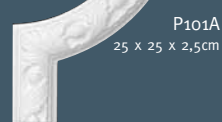

P101A  
25 x 25 x 2,5cm



P21  
6,5 x 6,5 x 1cm



P2020/P2020F



P201A  
25 x 25 x 2,5cm



P6020/P6020F



P8040, P21



P7080, PX103



P2020



P7030



P7020, 2 x P4020



P7060

# PANEL MOULDINGS

L: 200cm

# SKIRTING



P5051  
P5051F



P5050  
P5050F



C353, P5051



C355, P5050



C353, P5051



C360, P5050



C356, P5050, P5051

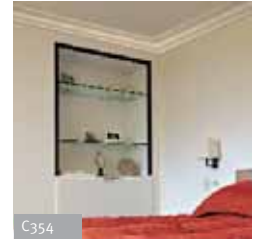

C354

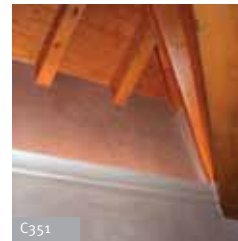

C351

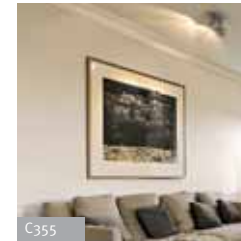

C355



C353



C356, C351



C354



P5050

ref+F = available in Flex, see page 44

with corner elements

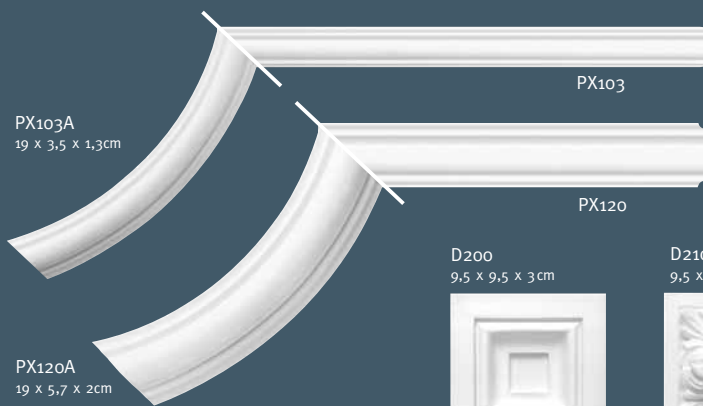
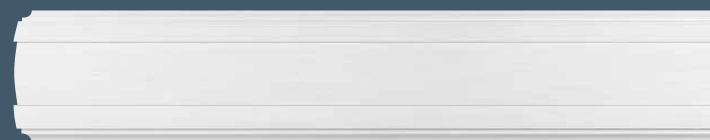

PX120A  
19 x 5,7 x 2cm

D200  
9,5 x 9,5 x 3cm



D210  
9,5 x 9,5 x 3,5cm

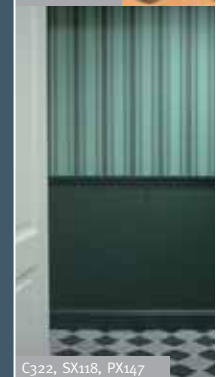
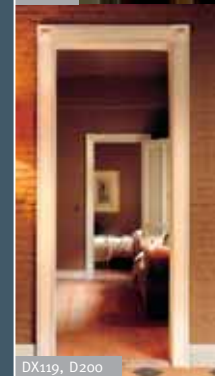
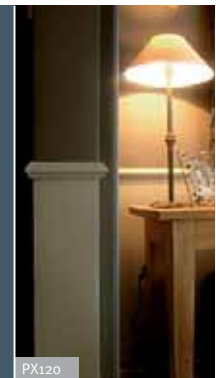



CX132



CX133

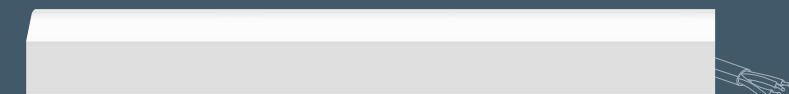

SX125



SX122

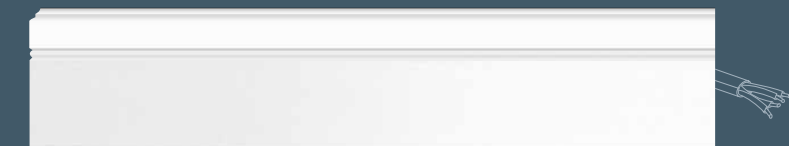

SX105/SX105F\*

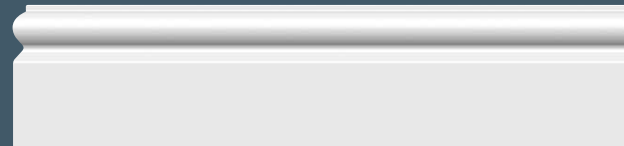

SX137

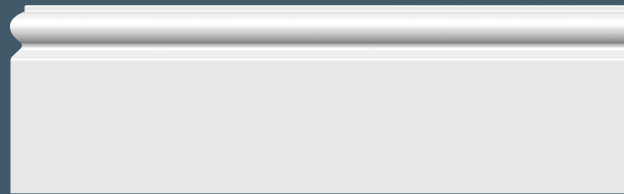

SX138

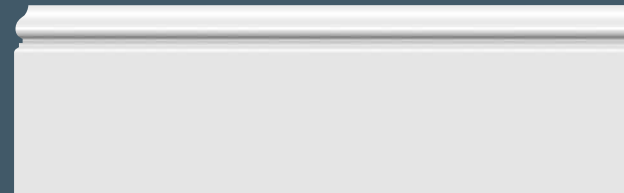

SX118/SX118F\*

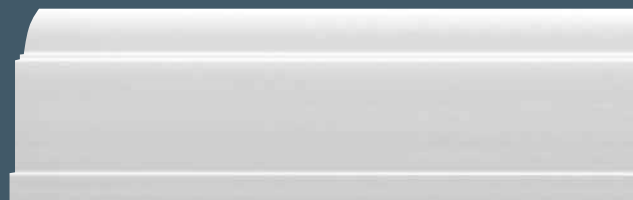

SX104



CX132



SX104



SX138



PX114, SX118, DX119

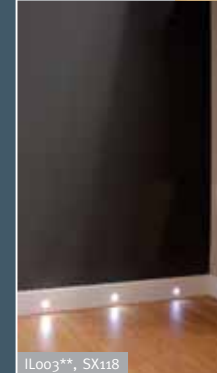

IL003\*\*, SX118

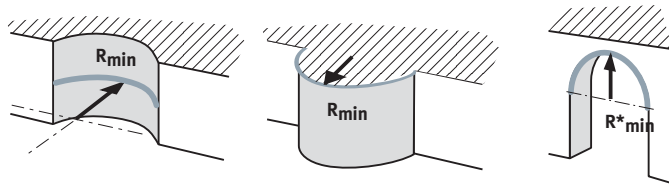

Flexible mouldings, available in all our existing **ORAC Decor** cornice and panel designs (+ SX105 and SX118 **ORAC Axxent**), give another dimension to your interior or exterior. Any curved wall can be beautifully decorated using these ORAC-Flex products. Please consult our radius applications-sheet or call for technical assistance. Use DecoFix Extra and Deco-Fix 2in1 for perfect installation (see page 79). Installation instructions are available. Length of moulding: 2 m.

Ref	Rmin (meter)
C200F	1,5
C201F	1,4
C211F	3,2
C212F	1,4
C213F	2,3
C214F	1,1
C215F	1,7
C216F	3,4
C217F	3,4
C218F	3,7
C219F	2,9
C220F	2,9
C230F	1,1
C240F	2,3
C250F	1,1
C260F	1,5
C300F	3,4
C301F	3,0
C302F	2,1
C303F	1,8
C304F	1,7
C305F	2,9

Ref	Rmin (meter)
C307F	4,6
C308F	1,4
C321F	1,4
C322F	1,2
C331F	4,6
C332F	4,9
C333F	3,7
C334F	4,1
C353F	2,9
C354F	2,9
C355F	2,9
C356F	2,9
C360F	2,9
C401F	1,8
C402F	1,8
C422F	3,7
C602F	1,4
C900F	4,0
C901F	3,7
C902F	4,0

Ref	Rmin (meter)	R*min (meter)
P1020F	0,3	0,8
P2020F	0,3	0,8
P3020F	0,9	1,8
P4020F	0,9	0,9
P5010F	0,5	2,7
P5020F	0,5	2,7
P5021F	0,3	0,8
P5050F	0,5	4,6
P5051F	0,5	4,6
P6020F	0,5	1,5
P7010F	0,3	3,0
P7020F	0,3	2,9
P7030F	0,3	1,5
P7040F	0,5	1,8
P7050F	0,5	1,5
P7060F	1,5	1,8
P7070F	0,5	2,7
P7080F	0,5	/
P8020F	0,5	1,4
P8030F	0,3	0,6
P8040F	0,3	2,9
P8050F	0,3	2,7
P8060F	0,3	3,0
P9010F	0,5	2,6
P9020F	0,5	2,7
P9040F	0,5	0,9
P9050F	0,3	0,8
<b>SX105F</b>	0,5	/
<b>SX118F</b>	0,5	/







D500 55 x 75 x 1,5 cm



D504 55 x 22 x 1,5 cm



D507 55 x 90,5 x 1,5 cm



F30 60 x 60 x 4 cm



D503 55 x 55 x 1,5 cm



D506 43 x 43 x 1,5 cm



F31 60 x 60 x 6,5 cm

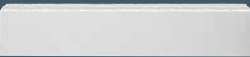

D505 57 x 12 x 1,5 cm

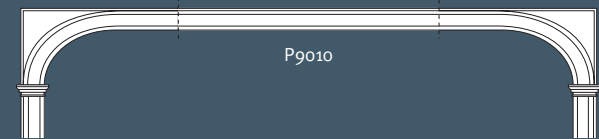
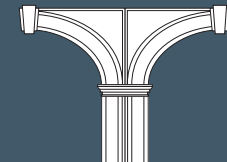
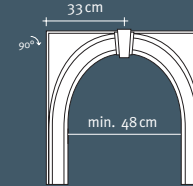
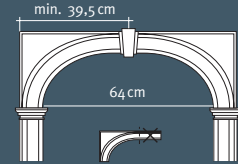
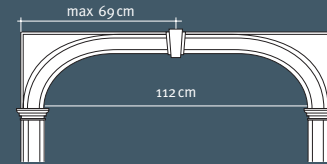

P9010/P9010F L: 200cm



D300 9,5 x 26 x 4 cm



Byblos



Byblos



Byblos

kit KX004  
1 x DX121, L: 107cm  
2 x DX121, L: 190cm  
2 x D210  
2 x D310

kit KX002  
1 x DX121, L: 107cm  
2 x DX121, L: 213cm  
2 x D210

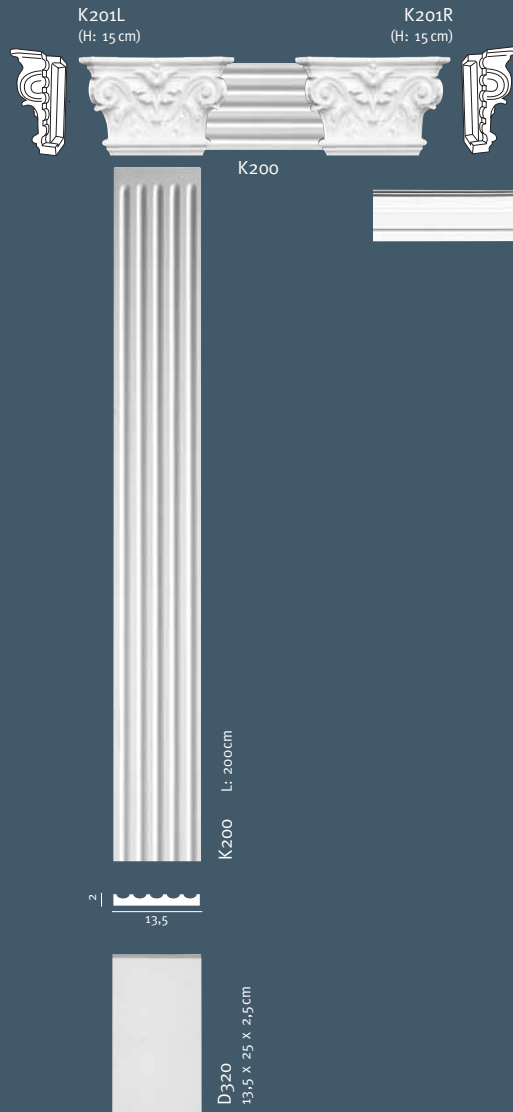
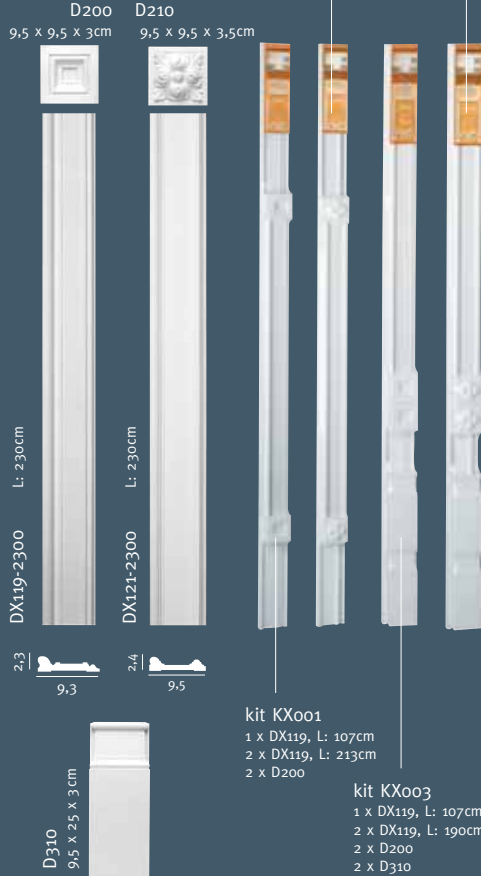

D102  
210,5 x 23,5 x 3 cm

D101  
125,5 x 19,5 x 3 cm

D200  
9,5 x 9,5 x 3cm

D210  
9,5 x 9,5 x 3,5cm

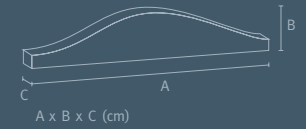
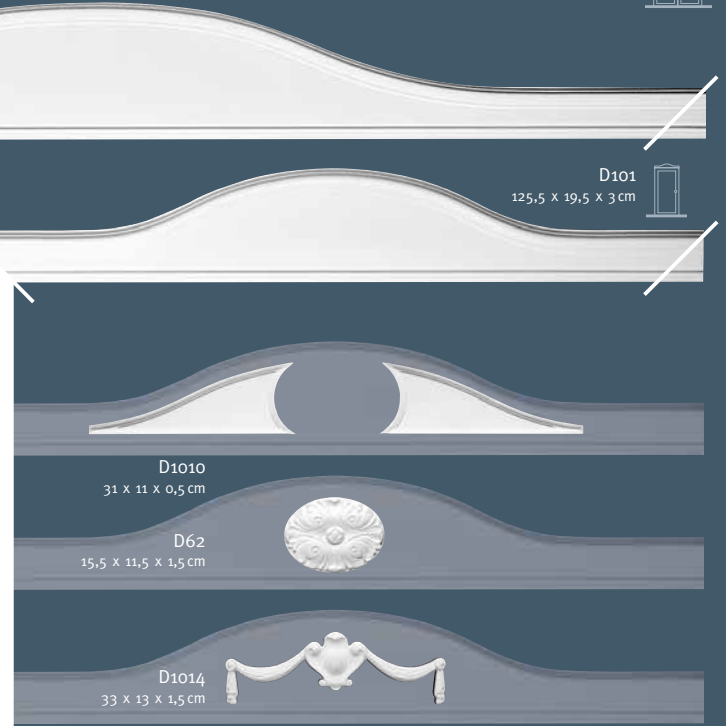

*Quality & Atmosphere*

*Exclusivity & Creativity*

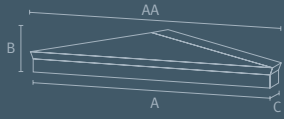

AA/A x B x C (cm)



D120

124/113 x 25 x 9 cm



D400

127,5/122 x 14,5 x 5,5 cm



D401

127,5/122 x 14,5 x 5,5 cm



D400 + D402

127,5/122 x 14,5 x 5,5 cm



2 x D401 + D402

max. 245,5/240 x 14,5 x 5,5 cm



D402

12/7 x 14,5 x 6 cm  
(only for D400 and D401)

D130  
116,5/110,5 x 36 x 6 cm



D140  
99 x 32 x 2 cm



D150  
100,5 x 15,5 x 1,5 cm



D160  
91,5 x 37 x 4 cm



D161  
92 x 21,5 x 4 cm



D170  
105 x 25 x 3,5 cm



D401, D402



D120, D130



D130, D1014



R35  
ø22cm



R10  
ø15cm



R11  
ø19cm



R12  
ø20cm



R13  
ø28,5cm



R74  
ø65,5cm



R28  
ø68,5cm



R50  
ø32cm



R14  
ø33,5cm



R31  
ø38,5cm



R61  
ø40cm



R52  
ø69,5cm



R73  
ø70cm



R16  
ø45cm



R17  
ø47cm



R18  
ø49cm



R46  
ø53,5cm



R22  
77 x 52,5cm



R77  
ø62cm



R38  
ø71cm



R23  
ø71,5cm



R12



R18



R38

ornamented

smooth

CEILING MEDALLIONS



R27  
ø75cm



R75  
ø75,5cm



R24  
ø79cm



R37  
ø85cm



R64  
ø95,5cm



R07  
ø26cm



R08  
ø38cm



R09  
ø48,5cm



R66  
ø54,5/43cm



R76  
ø62cm



R40  
ø74,5cm



R64



R09



R40

*Exclusivity & Creativity*

ceiling tiles

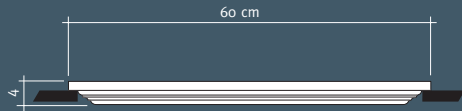

F30  
60 x 60 x 4 cm

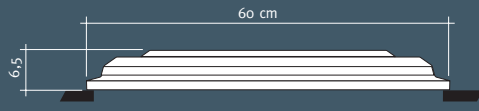

F31  
60 x 60 x 6,5 cm

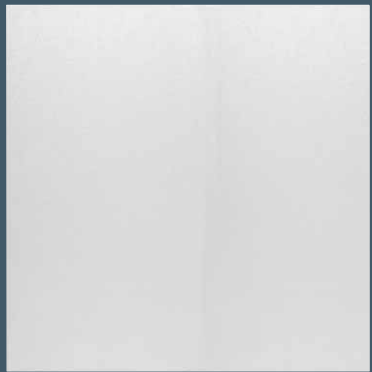

F32  
60 x 60 x 0,4 cm

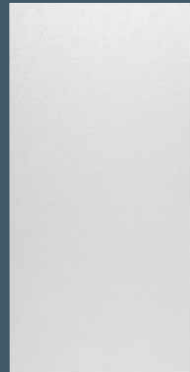

F33  
60 x 30 x 0,4 cm

domes



F10

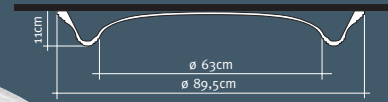

F11

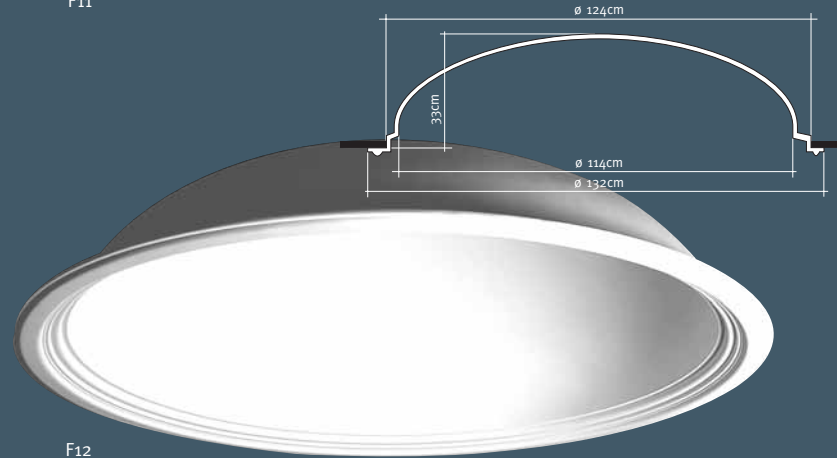
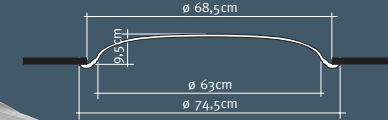

F12

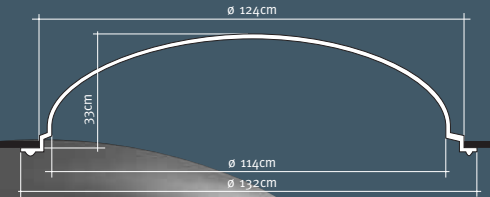

CEILING ORNAMENTS

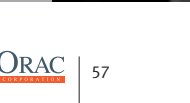



L504  
30,5 x 15 x 15cm



L505  
41 x 11,5 x 16,5cm



L512  
30,5 x 12,5 x 15,5cm

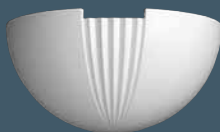

L509  
29 x 17 x 14,5cm



L510  
35,5 x 19 x 14cm



L501  
35 x 22 x 16cm



L506  
39 x 15,5 x 19cm



L508  
33 x 21,5 x 14cm



L511  
27 x 26 x 14cm

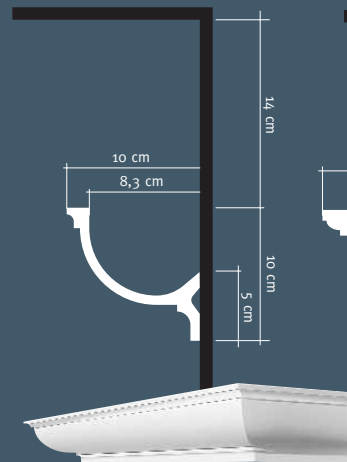

C902/C902F

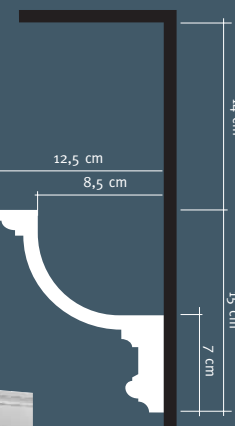

C901/C901F

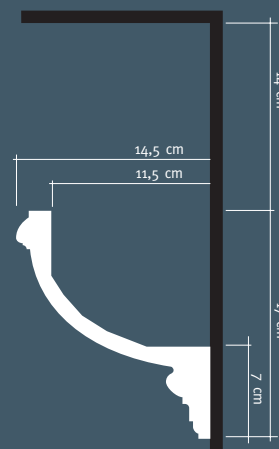

C900/C900F

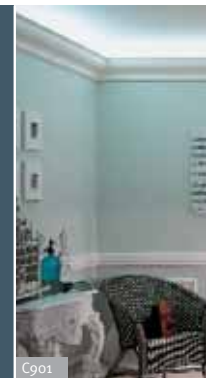

C901



C901



C902



max.  
9W/230V



max.  
60W/230V  
halogen



max.  
60W/230V

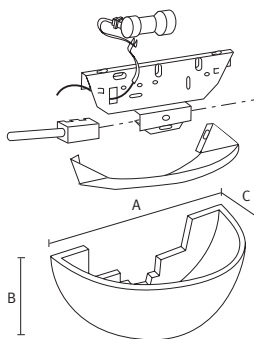

A x B x C (cm)

technical information on  
[www.oracdecor.com](http://www.oracdecor.com).  
Lightbulbs not supplied by ORAC.



IL100  
set 2m, 14 sockets incl.



IL110  
15 x lamp, Vacuum 10W, 12V

See next page for lightplates.

Exclusivity & Creativity

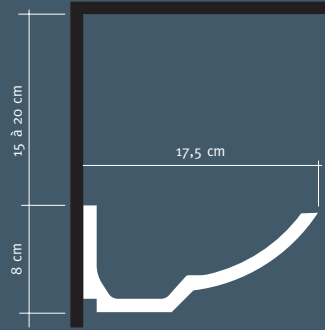

C351

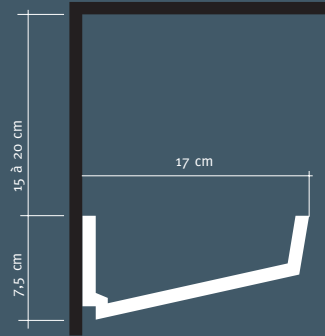

C352

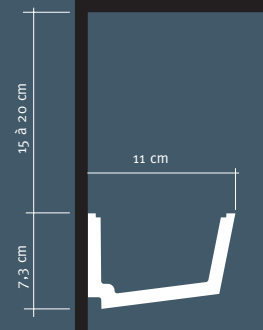

C357

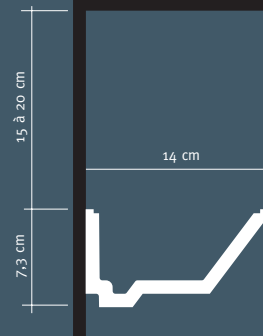

C358



C352



C352



IL001-004  
light plate 2230mm  
dimmable - T5 2x28W

IL001-002  
light plate 550mm  
dimmable - T5 1x14W



IL000-001 5 x plexi cover for C357, 100cm  
IL000-002 5 x plexi cover for C358, 100cm



C357

Lightplates to use with C900, C901, C902, C351, C352, C357, C358.  
Check detailed installation instructions in packaging, for more  
information about number of lightplates, connection to the main  
electricity supply and wiring chart.

technical information in USER MANUAL and on  
[www.oracdecor.com](http://www.oracdecor.com).  
Lamps not supplied by ORAC.



L600-001  
for compact fluorescent <sup>1)</sup>  
18W  
**Up & down light**  
19,5 x 34 x 8,5 cm

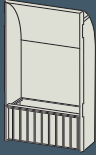

L600-002  
for halogen lamp <sup>2)</sup>  
60W or 100W  
**Uplight only**  
19,5 x 34 x 8,5 cm



L601-001  
for MycroLynx F 7W (white & color) <sup>3)</sup>  
or MycroLynx LED (white & color) <sup>4)</sup>  
10 x 9 x 10 cm



IL003  
(in SX118)

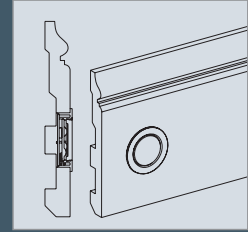

L600, SX104



L601



technical information in USER MANUAL and on  
[www.oracdecor.com](http://www.oracdecor.com).  
Lightbulbs/lamps not supplied by ORAC.



Use IL003 for example in C220, C305, C400, C354, P5050, P5051, SX104, SX105, SX118, SX137, SX138, Tfo6, ...



IL003-001  
set of 5 LED inserts, 1W  
Ø4 cm x 9 mm  
+ convertor max. 5 units  
+ 5 cables 1m



IL003-002  
power convertor  
max 40 units

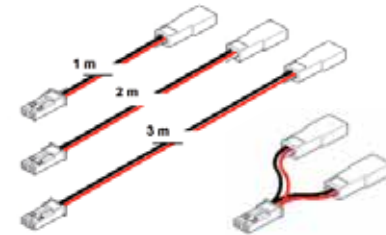

IL003-003  
extension cable  
1x (1+2+3m)

IL003-004  
multi-connector  
5 x Y-connector



IL003 in SX118

*Exclusivity & Creativity*

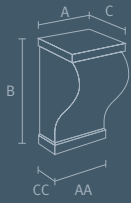

A x B x C (cm)  
AA x CC (cm)

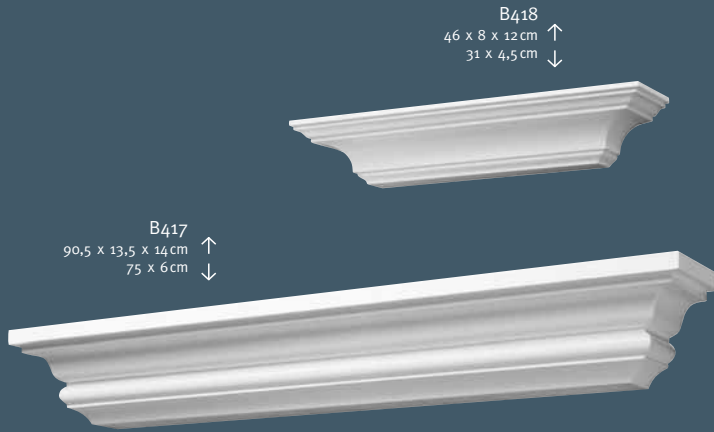

B418  
46 x 8 x 12 cm ↑  
31 x 4,5 cm ↓

B417  
90,5 x 13,5 x 14 cm ↑  
75 x 6 cm ↓



B410  
19,5 x 50 x 16 cm



B412  
20 x 35 x 20 cm



B415  
26 x 32,5 x 13 cm



B409  
30 x 35 x 17,5 cm



B413  
16 x 22,5 x 8,5 cm



B414  
10 x 22 x 7 cm



B408  
22,5 x 40 x 13 cm



B404  
19,5 x 31,5 x 11,5 cm



B403  
19 x 19 x 10 cm



B402  
9 x 22 x 7 cm



B401  
11,5 x 15,5 x 7 cm



B403



B401



B410

*Exclusivity & Creativity*



(cm)	A	B	C	AA	BB
N403	43,0	70,5	10,0	26,5	55,0
N404	42,0	76,0	11,0	24,5	55,0
N503	69,0	112,5	11,0	51,5	94,5
N504	69,0	113,0	11,0	49,5	94,5

  

(cm)	F	G	H	FF	GG
N410	31,0	59,5	9,5	28,0	58,5
N510	55,0	98,5	18,0	53,0	96,0
N520	55,0	97,5	18,0	53,0	92,0



Exclusivity & Creativity

Place the lightbulb (max. 60W) at min. 10cm. distance from the opaque base. Lightbulb not supplied by ORAC.

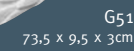
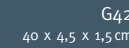
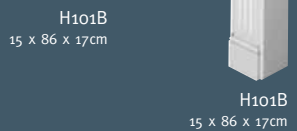
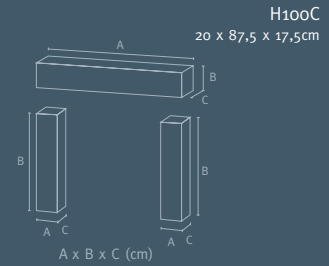

The mantelpieces are **only decorative elements**. They can only be applied with electrical fires (max. 2-3kW).

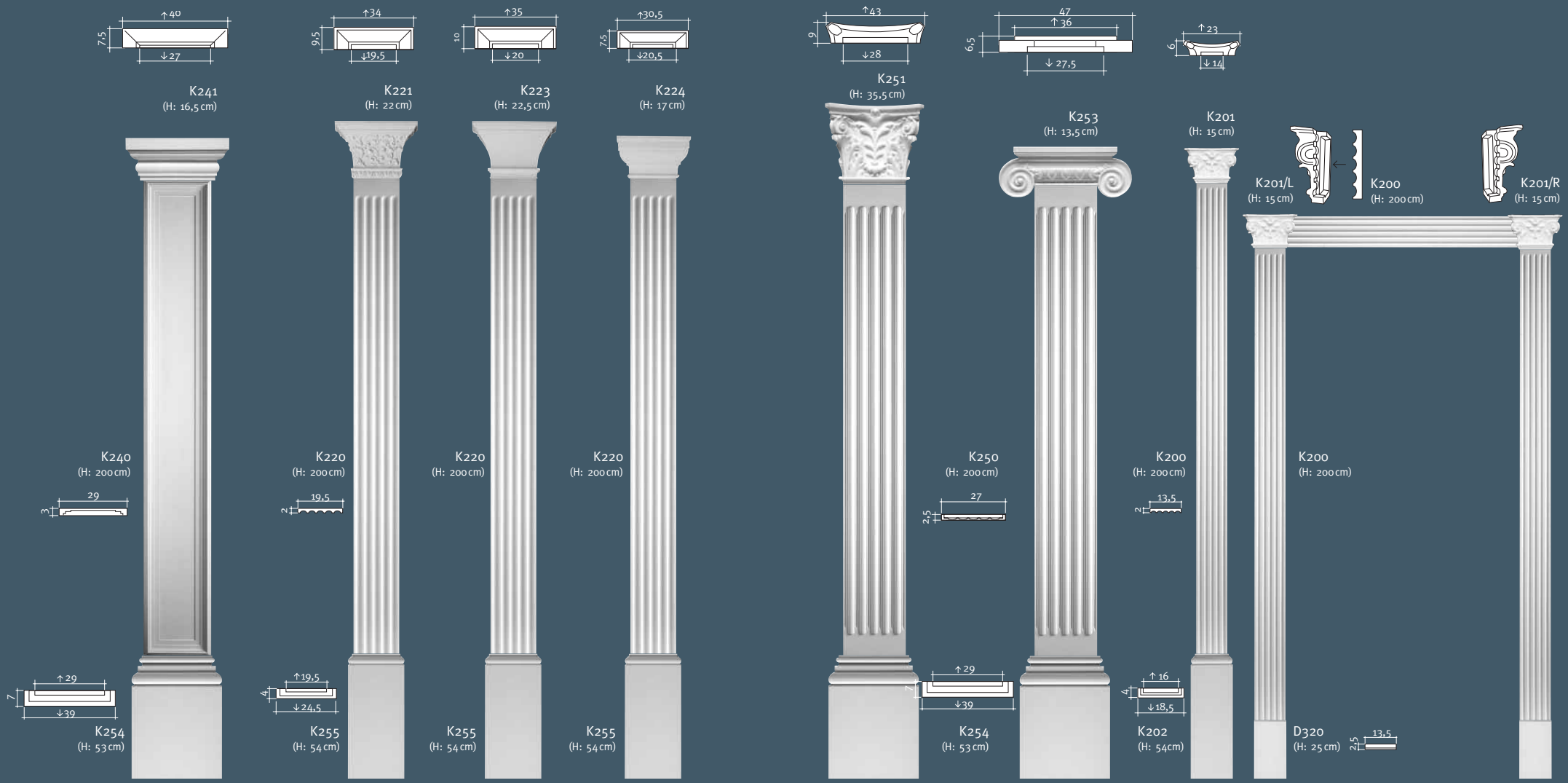

*Exclusivity & Creativity*

**Model KC3** Hmax/min = 2,415m  
**Model KD5** Hmax/min = 2,42m  
**Model KI.5** Hmax/min = 2,425m  
**Model KC1** Hmax/min = 2,425m  
**Model KD1** Hmax/min = 2,43m  
**Model KI.1** Hmax/min = 2,455m  
**Model K3112** (H: 12,5cm)  
**Model K3142** (H: 16cm)  
**Model KC4** Hmax = 2,865m / Hmin = 2,50m  
**Model KD6** Hmax = 2,87m / Hmin = 2,505m  
**Model KI.6** Hmax = 2,695m / Hmin = 2,33m  
**Model KC2** Hmax = 2,875m / Hmin = 2,51m  
**Model KD2** Hmax = 2,88m / Hmin = 2,515m  
**Model KI.2** Hmax = 2,705m / Hmin = 2,34m  
**Model K3002** (H: 201cm)  
**Model K3102** (H: 202cm)  
**Model K1152** (H: 12cm)  
**Model K1112** (H: 57cm)  
**Model K1142** (H: 29,5cm)  
**Model K1112** (H: 30cm)  
**Model K1142** (H: 12,5cm)  
**Model K3152** (H: 20cm)  
**Model K3152** (H: 57,5cm)



XL-segmented column

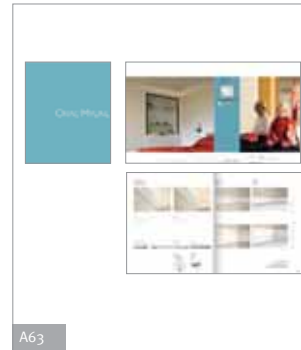
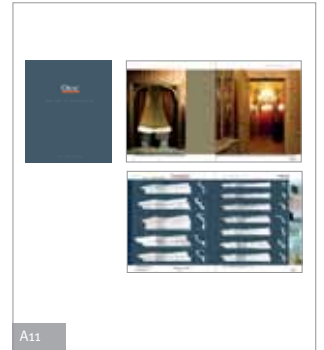
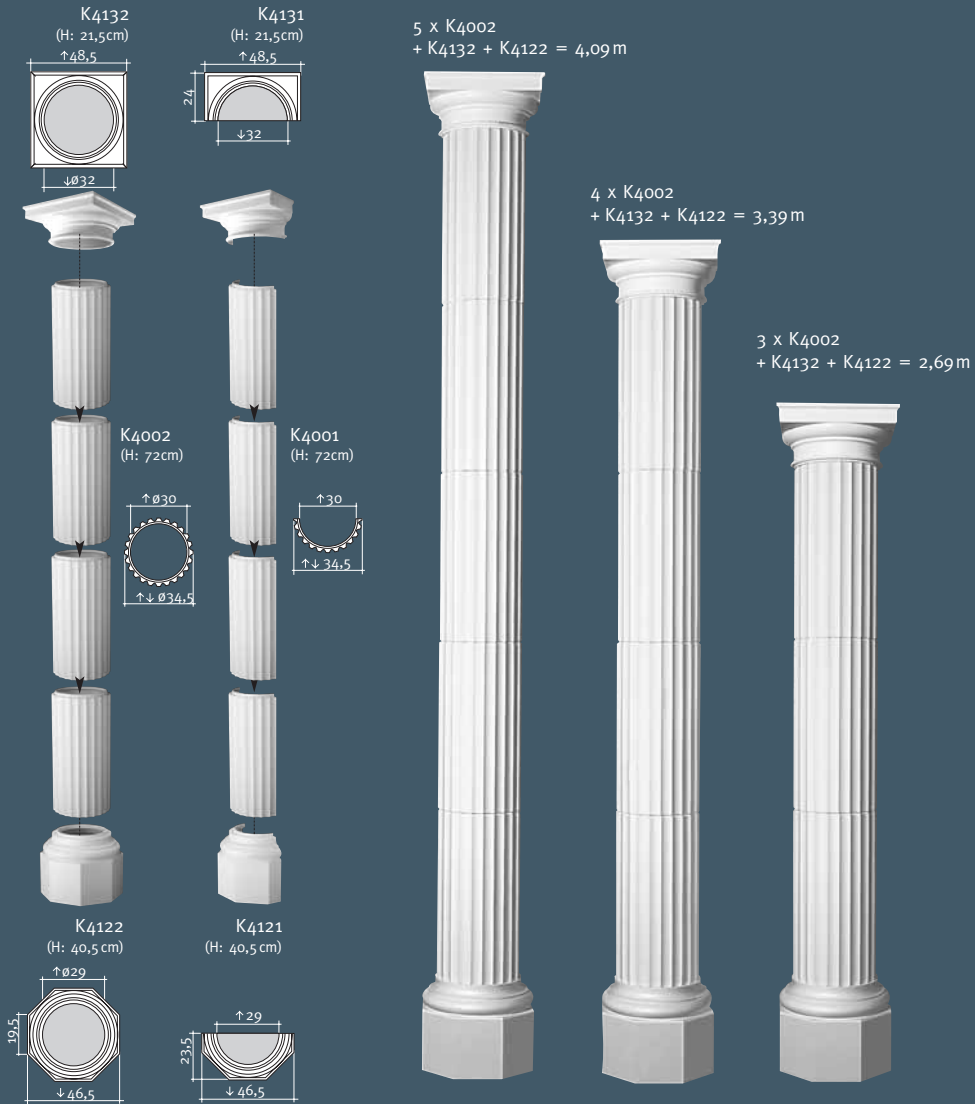

Exclusivity & Creativity





FB13



FB14



FB300



FDP100



FB10 Variomatic



A24

ORAC ornaments are unbreakable, light and easy to install. They are processed in the same way as light wood and finished with a quality primer.

You will find all the technical information on our website.

Guarantee Terms and Conditions apply provided instructions have been followed to the letter.

Check the measurements of the ornaments on the premises before you start installing them, there may be some discrepancies or changes in sizes against those stated in the catalogue.

**FIRE RETARDANT STANDARDS**

In many interiors and projects strict fire regulations are imposed.

Therefore, ORAC has elaborated a number of solutions depending on the country and its regulations. Please contact our engineering department for more detailed requests.

You will find further product information and safety regulations in our Product Info Brochure and on [www.oracdecor.com](http://www.oracdecor.com).



DecoFix Pro

FDP500 310ml 7 à 8m  
FDP600 2700ml ± 48m



DecoFix 2in1

FDP800 310ml 7 à 8m



DecoFix Hydro

FDP700 290ml 7 à 8m



DecoFix Extra

FX200 310ml ± 150m  
FX210 80ml ± 40m

**DECOFIX PRO**  
Extra strong  
installation adhesive

A slow-drying EXTRA STRONG glue that ensures a long lasting seal between the mouldings and the wall and/or the mouldings and the ceiling (for both Decor and Axxent ranges). It can be painted after hardening (24 hrs).

**DECOFIX 2in1**  
Installation adhesive and  
joint filling product

A slow-drying glue that ensures a long lasting seal between the mouldings and the wall and/or the mouldings and the ceiling (for both Decor and Axxent ranges). The adhesive can also be used as a filling product and can be removed with water. It can be painted after hardening (24 hrs).

**DECOFIX HYDRO**  
Installation adhesive and  
joint filling product  
for exterior applications

Use DecoFix Hydro for exterior applications and in damp environments instead of DecoFix 2in1.

**DECOFIX EXTRA**  
Joint adhesive

A glue for seam joints between the mouldings (for both Decor and Axxent ranges). Any excess of DecoFix Extra can be removed preferably before hardening (with acetone). It can be sanded after hardening (at least two hours). The adhesive can be painted after 24 hrs.

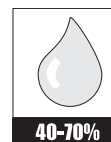



This catalogue and the designs embodied within are protected by copyright law and international treaties. Unauthorized reproduction of the catalogue or any portion of it or reproduction of any of the designs embodied therein may result in severe civil and criminal penalties and will be prosecuted to the maximum.

All rights reserved. ©2007, ORAC n.v.

Layout: FABworks.be

## Headquarter

nv **ORAC sa**

Oudenburgsesteenweg 90

B-8400 Oostende

Tel: +32 (0)59-803 252

Fax: +32 (0)59-802 810

sales@oracdecor.com



CONTEMPORARY



COUNTRY STYLE



TRADITIONAL CHIC



ARTISTIC LIVING

[www.oracdecor.com](http://www.oracdecor.com)